

Handle

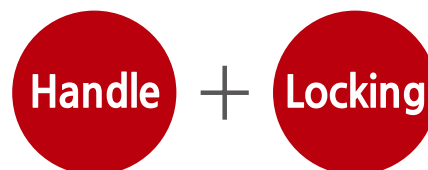

Smart easy handle

In terms of structure installed by dividing the previous locking device and handle, Smart Easy handle is **extremely convenient product in the installing construction** as the patent registered technology realizing **the unification of handle and locking device first in the business world** through the steady research development of CS Tech Co., Ltd.



- The constructability is extremely good as the integral structure of locking device and handle.
- The construction is convenient without division of left and right.
- The durability is high with the smooth action of handle lever.
- It is well matched to any windows and doors as the design is simple.

A0304 Smart easy lock (assistance)



A0303 Smart easy lock (large)

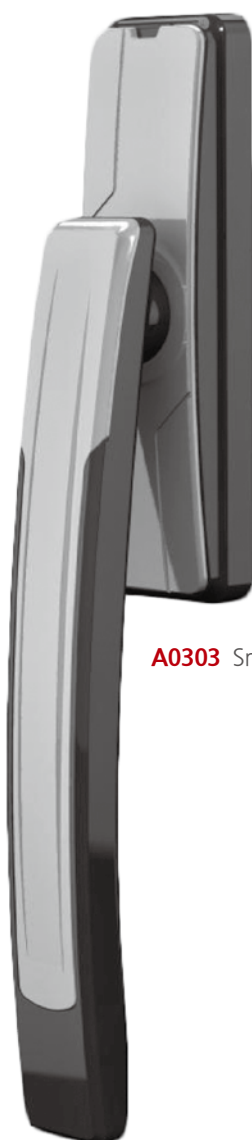

A0301 Smart easy lock (left)

A0302 Smart easy lock (right)



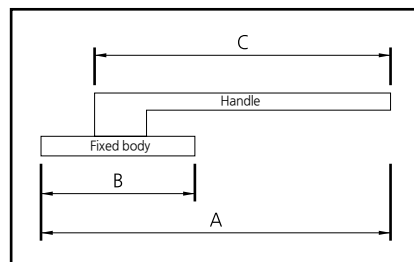

The product standard of Smart easy handle

Name of product	A	B	C	Color	Box obtention
A0303 (Large)	250mm	130mm	200mm	Silver	20ea
A0301 (Left)	250mm	130mm	200mm	Silver	20ea
A0302 (Right)	250mm	130mm	200mm	Silver	20ea
A0304 (Assistance)	190mm	130mm	145mm	Silver	40ea

There may be somewhat difference in the drilling position according to the manufacturer.

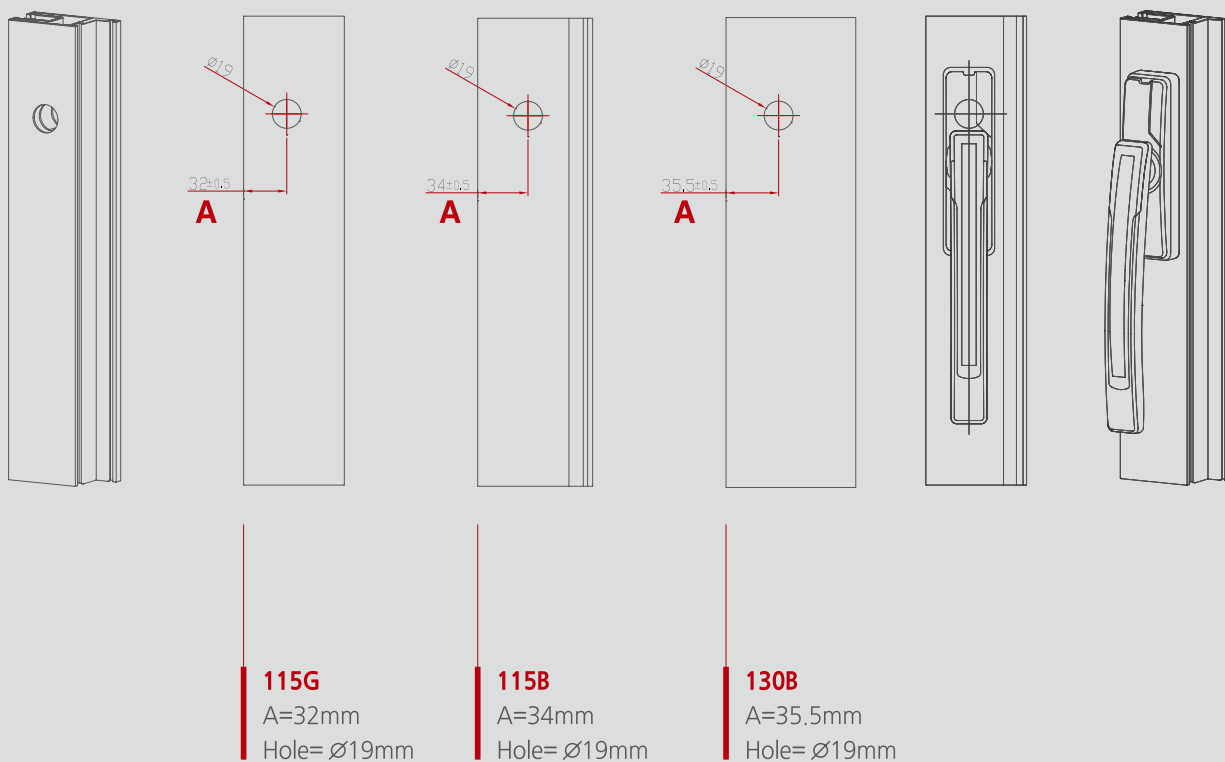

I Smart handle



- The alarm sounds occurs at time of compulsory opening from outside.
- The operating state may be known by applying the alarm sound in the operation of handle.
- The durability is high owing to the smooth operation of handle lever.
- It is convenient to insert the battery and install the products easily as the cover is separated.
- The security function has been reinforced with the automatic locking device and the alarm bell.



A0203
The handle of smart 1 letter type
(design has been registered)



A0204
The assistance handle of smart
(design has been registered)

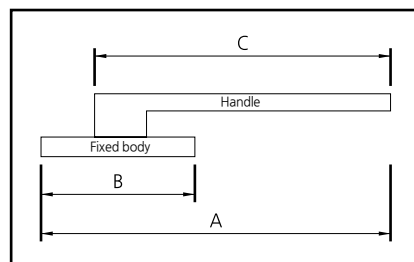

The product standard of smart handle

Name of products	A	B	C	Color	Box obtention
A0203 (Large)	250mm	135mm	195mm	Silver / Gold	20ea
A0201 (Left)	250mm	135mm	195mm	Silver / Gold	20ea
A0202 (Right)	250mm	135mm	195mm	Silver / Gold	20ea
A0204 (Assistance)	190mm	135mm	195mm	Silver / Gold	40ea

Function of crime prevention

External intrusion
The compulsory opening of balcony and windows and doors from the outside

The sound of strong alarm

Simple installation and convenient exchange of battery

Coin battery

The insertion of battery and installation of products are convenient as the cover is rotated.

	ANGLE (L-shaped)	STRAIGHT (1 letter type)	GRIP (Assistant handle)
Name of model			
90°C manual rotation T/S	—	A0205	A0206
180°C manual rotation L/S	—	A0207	A0208

I Edge handle



- The alarm sound occurs at time of compulsory opening from outside.
- The operating state may be known by applying the alarm sound in the operation of handle.
- The durability is high owing to the smooth operation of handle lever.
- It is convenient to insert the battery and install the products easily as the cover is separated.
- The security function has been reinforced with the automatic locking device and the alarm bell.

A0101
Edge handle (small)



A0102
Edge handle (middle)



A0103
Edge handle (large)



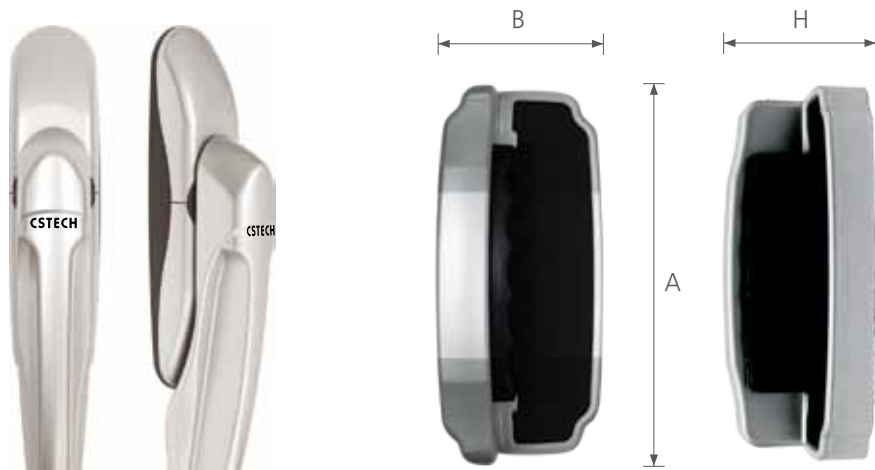

A0104
(Assistant handle)

A1603
Grip handle
(new type)

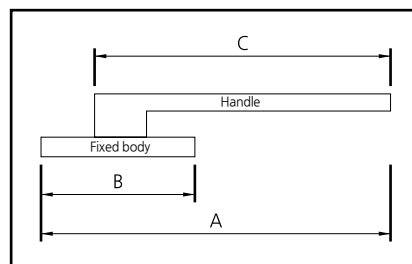

The product standard of Edge handle

Name of product	A	B	C	Color	Alarm device	Box obtention
A0101 (Large)	320mm	145mm	280mm	Silver	Existence(BL)/Nonexistence(L)	20ea
A0102 (Middle)	240mm	145mm	200mm	Silver	Existence(BM)/Nonexistence(M)	20ea
A0103 (Small)	180mm	145mm	130mm	Silver	Existence(BS)/Nonexistence(S)	40ea
A0104 (Assistant)	195mm	145mm	145mm	Silver	Existence(BM)/Nonexistence(S)	40ea
A1603 Grip handle (new type)	130mm	60mm	44mm (H)	Silver	-	40ea

Function of crime prevention

External intrusion
The compulsory opening of balcony and windows and doors from outside

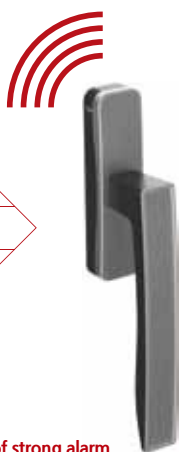

Simple installation and convenient exchange of battery

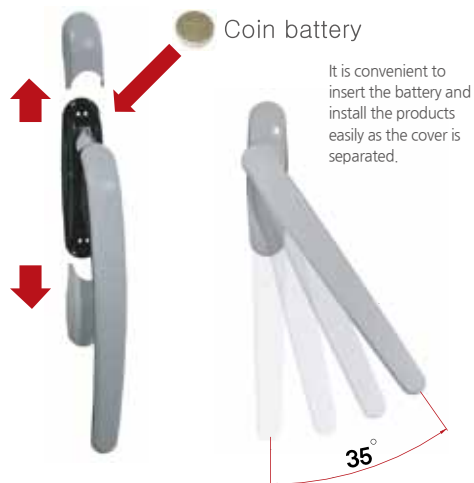

Crystal handle

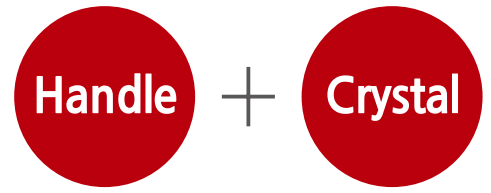

- More luxurious mood may be directed by applying the luxurious crystal cubic in the floral design that the pearl of various colors is added.
- The durability is high with the smooth operation of handle lever.



More luxurious mood may be directed by applying the luxurious crystal cubic.

A0809
Crystal handle (small)



A0808
Crystal handle (middle)



A0807
Crystal handle (large)





Sky blue

Yellow green

Champagne gold

Secret white

A1501

Fixed handle

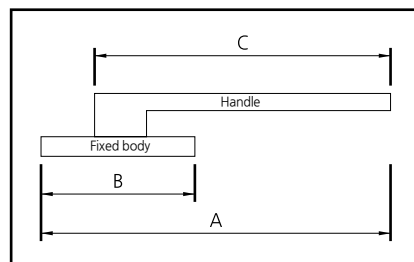
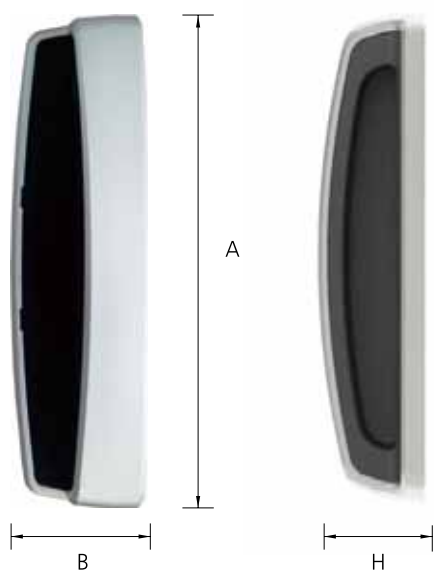

The product standard of crystal handle

Name of products	A	B	C	Color	Box obtention
A0807 (Large)	350mm	150mm	290mm	Silver+G (B / S / W)	20ea
A0808 (Middle)	245mm	150mm	190mm	Silver+G (B / S / W)	20ea
A0809 (Small)	185mm	150mm	130mm	Silver+G (B / S / W)	40ea
A1051 Fixed handle	160mm	40mm	33mm (H)	-	100ea

Simple handle

Simple handle

The simplicity is the characteristic as the white cover is used at time of high grow.

Simple handle (large)
A0801

Simple handle (middle)
A0802

Simple handle (small)
A0803

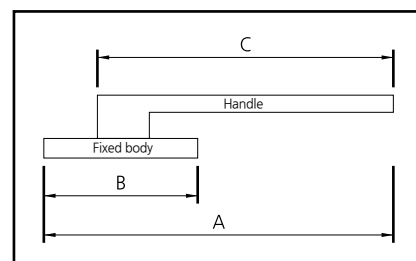

The product standard of simple handle

Name of product	A	B	C	Color	Box obtention
A0801 (Large)	350mm	150mm	290mm	Silver	20ea
A0802 (Middle)	245mm	150mm	190mm	Silver	20ea
A0803 (Small)	185mm	150mm	130mm	Silver	40ea

Simple 2 Floral design handle

The elegant and beautiful designs are the characteristic as the flower design is used.

Simple 2 floral handle (large)
A0804

Simple 2 floral handle (middle)
A0805

Simple 2 floral handle (small)
A0806



The product standard of simple 2 floral design handle

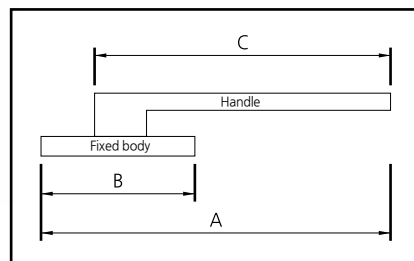

Name of product	A	B	C	Color	Box obtention
A0804 (Large)	350mm	150mm	290mm	Silver	20ea
A0805 (Middle)	245mm	150mm	190mm	Silver	20ea
A0806 (Small)	185mm	150mm	130mm	Silver	40ea